

Follower assembly

Model 83366, 83369, 278964 and 278965

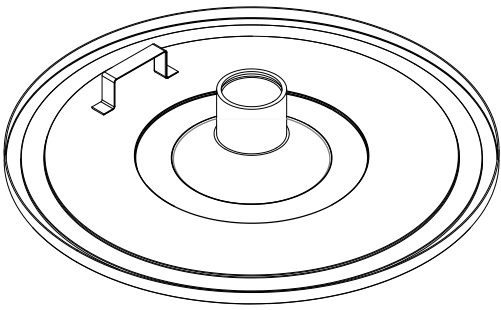

Date of issue **July 2014**

Form number **403348B**

Section **K5**

Page **9B**

⚠ DANGER

Read manual prior to installation or use of this product. Keep manual nearby for future reference. Failure to follow instructions and safety precautions may result in death or serious injury.

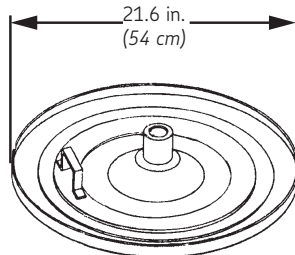
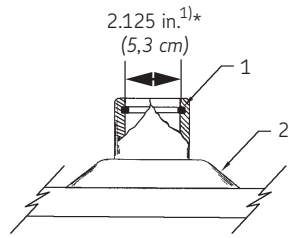

83369 follower
400 lb. (181 kg) drum
Standard PowerMaster

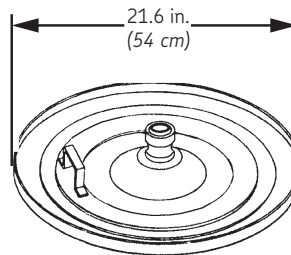
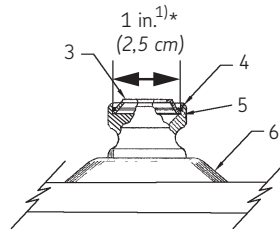

83366 follower
400 lb. (181 kg) drum
Series 20 and 40

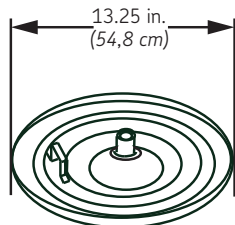
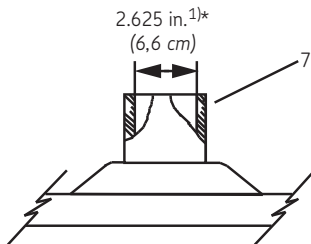

278964 follower
120 lb. (54 kg) drum
Ultra high pressure PowerMaster

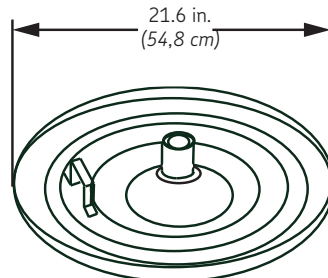
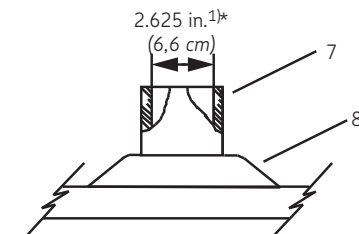

278965 follower
400 lb. (181 kg) drum
Ultra high pressure PowerMaster

Service parts

Item no.	Part no.	Qty.	Description
1	34337	1	O-ring
2	91957	1	Follower plate
3	13097	1	Gasket guard
4	68411	1	Retaining ring
5	38067	1	Flat washer
6	91954	1	Follower plate
7	278992	1	O-ring
8	278962	1	Follower

¹⁾ Pump tube diameters
* Indicates change

Lincoln industrial standard warranty

Standard limited warranty

Lincoln warrants the equipment manufactured and supplied by Lincoln to be free from defects in material and workmanship for a period of one (1) year following the date of purchase, excluding there from any special, extended, or limited warranty published by Lincoln. If equipment is determined to be defective during this warranty period, it will be repaired or replaced, within Lincoln's sole discretion, without charge.

This warranty is conditioned upon the determination of a Lincoln authorized representative that the equipment is defective. To obtain repair or replacement, you must ship the equipment, transportation charges prepaid, with proof of purchase to a Lincoln Authorized Warranty and Service Center within the warranty period.

This warranty is extended to the original retail purchaser only. This warranty does not apply to equipment damaged from accident, overload, abuse, misuse, negligence, faulty installation or abrasive or corrosive material, equipment that has been altered, or equipment repaired by anyone not authorized by Lincoln. This warranty applies only to equipment installed, operated and maintained in strict accordance with the written specifications and recommendations provided by Lincoln or its authorized field personnel.

This warranty is exclusive and is in lieu of any other warranties, express or implied, including, but not limited to, the warranty of merchantability or warranty of fitness for a particular purpose. Warranty on items sold by Lincoln, but not manufactured by Lincoln are subject to the warranty consideration, if any, of their manufacturer (such as hoses, hydraulic and electric motors, electrical controllers, etc.) Assistance in making such warranty claims can be offered as required.

In no event shall Lincoln be liable for incidental or consequential damages. Lincoln's liability for any claim for loss or damages arising out of the sale, resale or use of any Lincoln equipment shall in no event exceed the purchase price. Some jurisdictions do not allow the exclusion or limitation of incidental or consequential damages, therefore the above limitation or exclusion may not apply to you.

This warranty gives you specific legal rights. You may also have other rights that vary by jurisdiction.

Customers not located in the Western Hemisphere or East Asia: Please contact Lincoln GmbH and Co. Kg, Walldorf, Germany, for your warranty rights.

Special limited warranties

Special limited 2 year warranty SL-V series, single injectors – 85772, 85782, and replacement injectors – 85771, 85781

Lincoln warrants the SL-V Injector series to be free from defects in material and workmanship for two (2) years following the date of purchase. If an injector model (single or replacement) is determined to be defective by Lincoln, in its sole discretion, during this warranty period, it will be repaired or replaced, at Lincoln's discretion, without charge.

Special limited 5 year warranty series 20, 25, 40 bare pumps, pmv bare pumps, heavy duty and 94000 series bare reels

Lincoln warrants series 20, 25, 40 bare pumps, PMV bare pumps, heavy duty (82206), mini bench (81133, 81323), and all 94000 LFR series (single arm and dual arm) bare reels to be free from defects in material and workmanship for five (5) years following the date of purchase. If equipment is determined by Lincoln, in its sole discretion, to be defective during the first year of the warranty period, it will be repaired or replaced at Lincoln's discretion, without charge. In years two (2) and three (3), the warranty on this equipment is limited to repair with Lincoln paying parts and labor only. In years four (4) and five (5), the warranty on this equipment is limited to repair with Lincoln paying for parts only.

Special limited 5 year warranty limited oil meters, limited fluid control valves, aod (air-operated diaphragm pumps)

Lincoln warrants the 712 series control valves, 912 series lube meters, electronic lube meters (980, 981, 982 series), our universal inline digital meters (812/813 series), and our AOD pump offering to be free from defects in material and workmanship for five (5) years following the date of purchase. If either is determined to be defective by Lincoln, in its sole discretion, during the warranty period, they will be repaired or replaced, at Lincoln's discretion, without charge.

Special DEF (diesel exhaust fluid) limited warranty

DEF products are warranted to be free from defects in material and workmanship for a period of one (1) year following the date of purchase. The following exceptions to the standard warranty period are in effect:

- **85700-30/85700-50 DEF hose reels (bare reel only),** 277251/277252 AC DEF pumps, and 277256 and 277257 DEF meters are warranted for two (2) years from date of purchase.
- **85623 DEF AOD (air operated diaphragm) pumps** are covered under the standard five (5) year AOD pump warranty.

If either is determined to be defective by Lincoln, in its sole discretion, during the warranty period, they will be repaired or replaced, at Lincoln's discretion, without charge.

Lincoln Industrial contact information

To find Lincoln Industrial's nearest service center call the following number; customer service 314-679-4200 (international number 01-314-679-4200) or you may also use our website www.lincolnindustrial.com

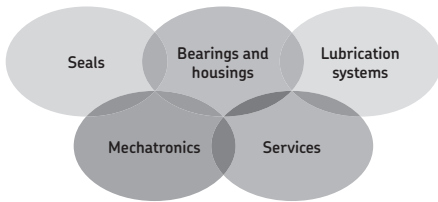

The Power of Knowledge Engineering

Combining products, people, and application-specific knowledge, SKF delivers innovative solutions to equipment manufacturers and production facilities in every major industry worldwide. Having expertise in multiple competence areas supports SKF Life Cycle Management, a proven approach to improving equipment reliability, optimizing operational and energy efficiency and reducing total cost of ownership.

These competence areas include bearings and units, seals, lubrication systems, mechatronics, and a wide range of services, from 3-D computer modelling to cloud-based condition monitoring and asset management services.

SKF's global footprint provides SKF customers with uniform quality standards and worldwide product availability. Our local presence provides direct access to the experience, knowledge and ingenuity of SKF people.

© SKF is a registered trademark of the SKF Group.

© Lincoln is a registered trademark of Lincoln Industrial Corp.

© SKF Group 2014 The contents of this publication are the copyright of the publisher and may not be reproduced (even extracts) unless prior written permission is granted. Every care has been taken to ensure the accuracy of the information contained in this publication but no liability can be accepted for any loss or damage whether direct, indirect or consequential arising out of the use of the information contained herein.

SKF PUB LS/l1 14823 EN.R1 · July 2014 · Form 403348B

